



Doosan Infracore
Machine Tools

DNM Series

High Productivity Vertical Machining Center



New series of vertical machining center

High quality and efficiency derived from high productivity analysis

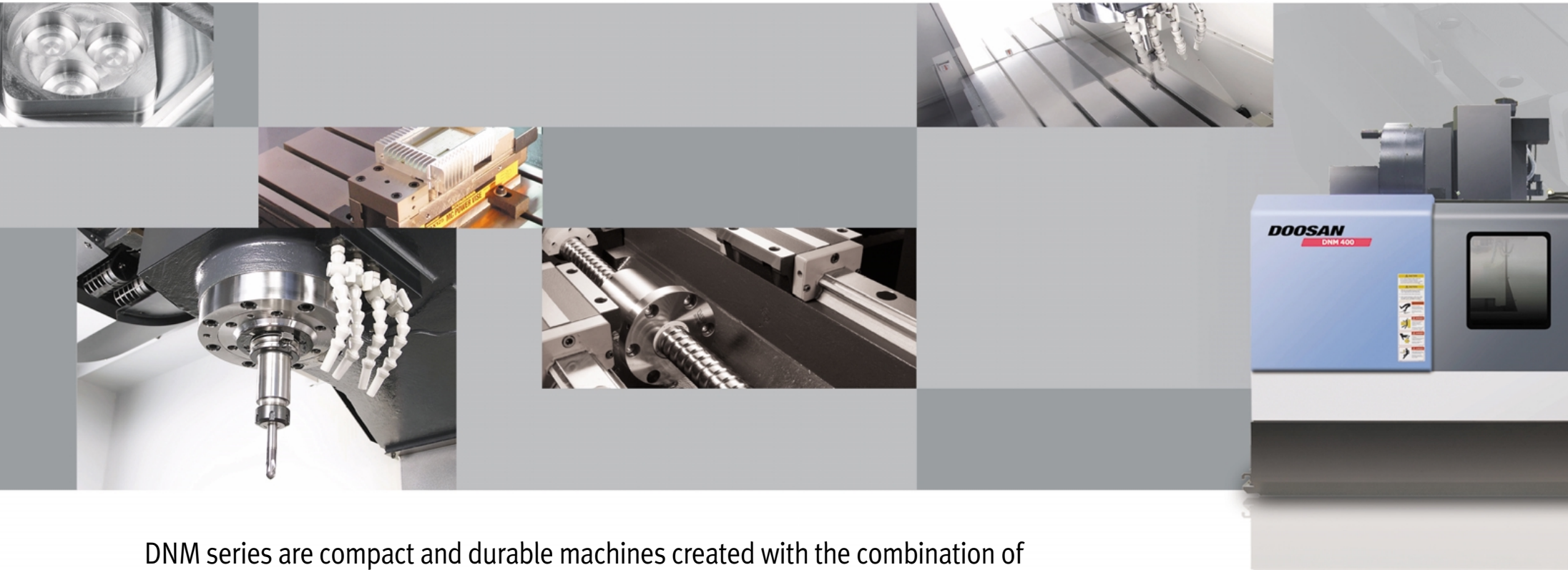

DNM series are compact and durable machines created with the combination of optimized function and increased rigidity to satisfy the quality goal of global class and cost-saving. The high productivity analysis is the major principle of the DNM series which have been designed with the user's needs in mind.

New series of Vertical machining center

DNM Series



High productivity DNM series

Basic concept structure and operation ensure its capability to get the best results of productivity regardless of any conditions and complexities

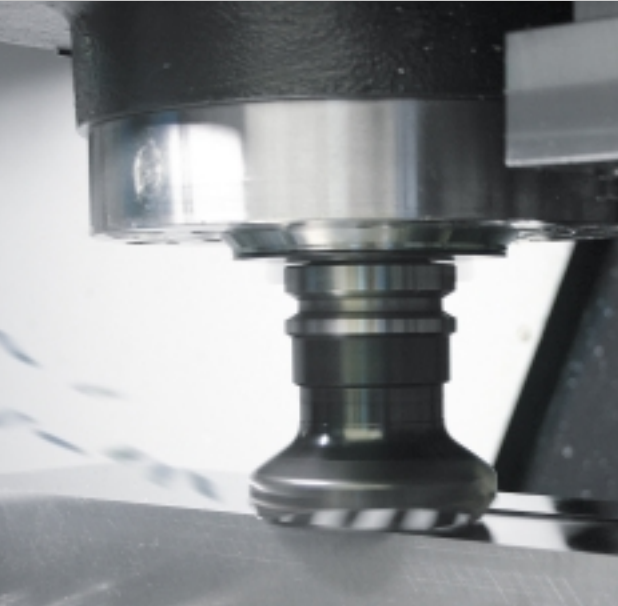

Comparison of Non Cutting Time

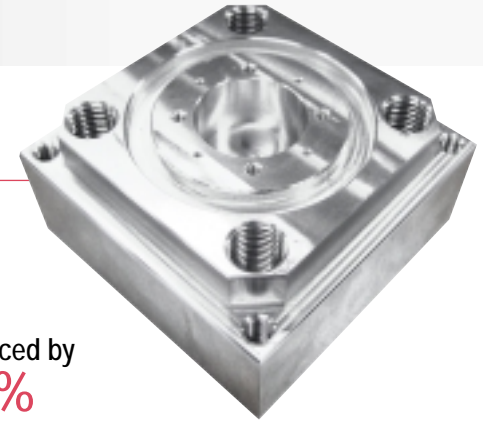
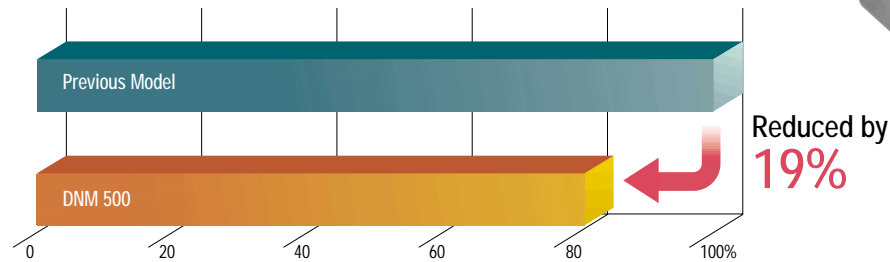

Material : Aluminum (Al6061-T6)
Size : 155 × 155 × 50 mm
(6.1 × 6.1 × 2 inch)
No. of tools used : 14 tools

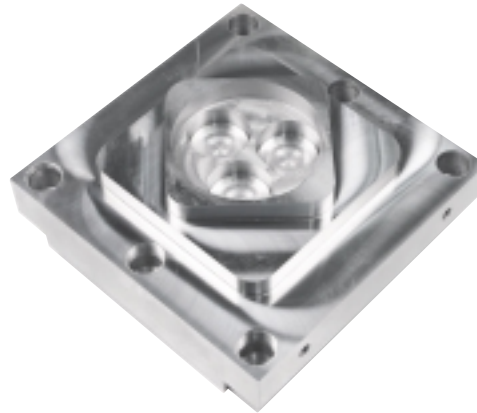

Material : Mold steel (HP4M)
Size : 270 × 270 × 100 mm
(10.6 × 10.6 × 3.9 inch)
No. of tools used : 5 tools

Comparison of Cutting Time

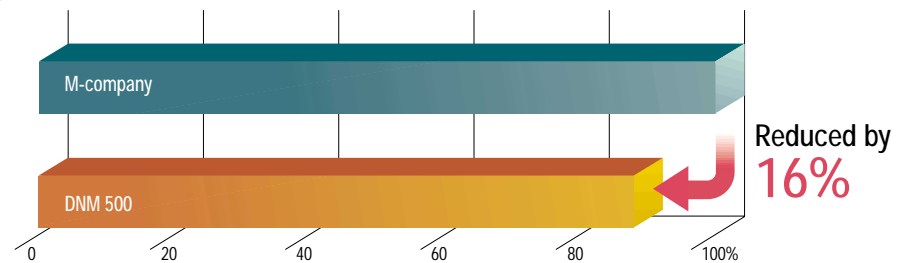

The results indicated in this catalog may not be obtained due to differences in cutting conditions.

Auto Tool Changer

Faster tool change time using cam increases productivity than previous model.

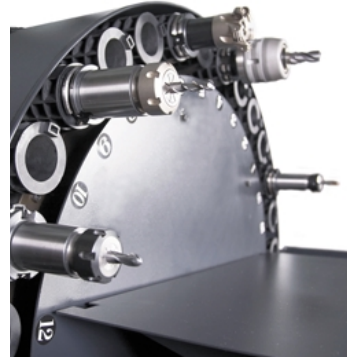

Tool change time (T-T-T)

Previous Model 1.5 s → DNM series 1.3 s

• This value is based on the motor on-off time and 60Hz.

Tool storage capacity

30 tools

40 tools opt.

Maximum Chip Removal

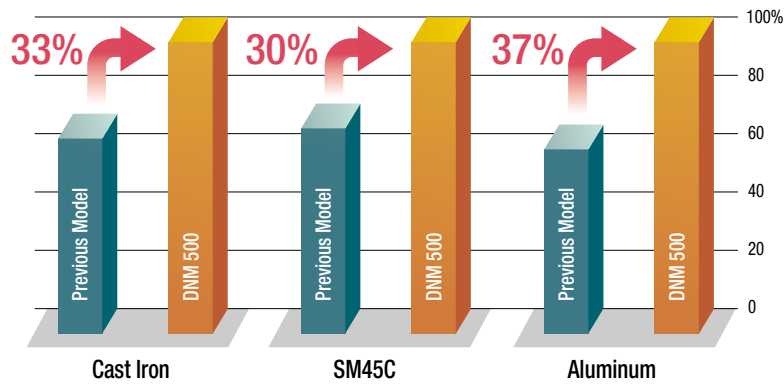

Rapid Traverse

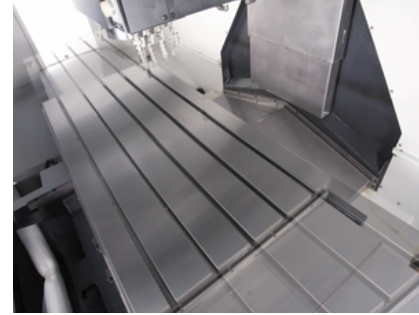

Linear motion guide ways and high speed servomotors apply high rapid axis movement. This reduces non-cutting time and machining time for greater productivity.

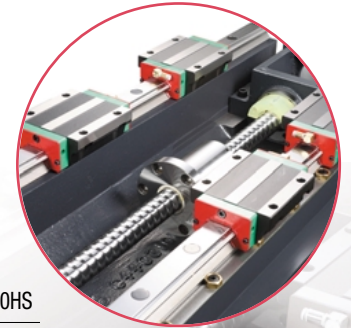

Rapid traverse

		DNM 400/500/650	DNM 400HS/500HS/650HS
X-axis	m/min (ipm)	36 (1417.3)	48 (1889.8)
Y-axis	m/min (ipm)	36 (1417.3)	48 (1889.8)
Z-axis	m/min (ipm)	30 (1181.1)	48 (1889.8)

Minimum thermal transformation for high accuracy std. only DNM HS series

Machine units are designed minimum thermal transformation by ball screw nut with cooling jacket.

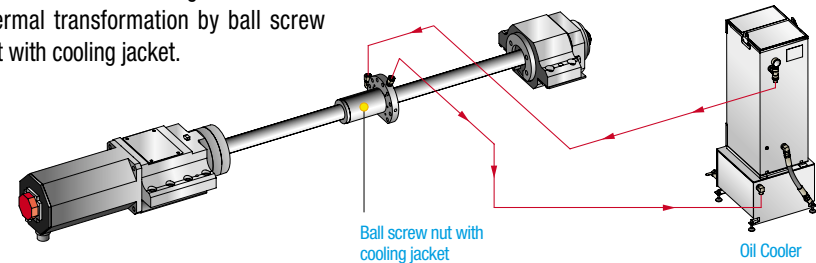

Machining Capacity (DNM 500)

Provides high-productivity and high-accuracy in a variety of machining operations

Face mill

Carbon steel (SM45C)

- ø80mm (3.15 in.) Face mill (6Z)

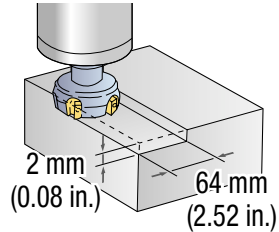

Machining rate
432 cm³/min (26.4 in³/min)

Spindle speed
1500 r/min

Feedrate
2700 mm/min (106.3 ipm)

End mill

Carbon steel (SM45C)

- ø30mm (1.2 in.) Endmill (6Z)

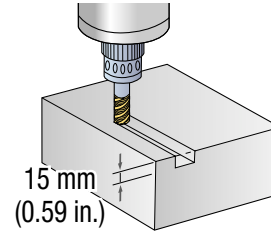

Machining rate
36cm³/min (2.2 in³/min)

Spindle speed
222 r/min

Feedrate
80 mm/min (3.1 ipm)

Face mill

Gray casting (GC25)

- ø80mm (3.15 in.) Face mill (6Z)

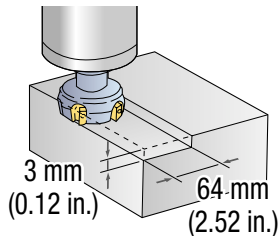

Machining rate
691 cm³/min (42.2 in³/min)

Spindle speed
1500 r/min

Feedrate
3600 mm/min (141.7 ipm)

U-drill

Carbon steel (SM45C)

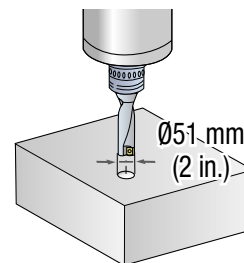

Machining rate
172 cm³/min (10.5 in³/min)

Spindle speed
750 r/min

Feedrate
84 mm/min (3.3 ipm)

Face mill

Aluminum (AL6061)

- ø80mm (3.15 in.) Face mill (6Z)

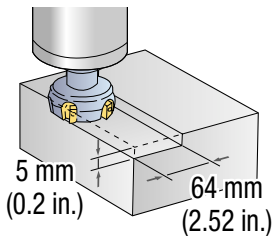

Machining rate
1785 cm³/min (109 in³/min)

Spindle speed
1500 r/min

Feedrate
5580 mm/min (219.7 ipm)

Tap

Carbon steel (SM45C)

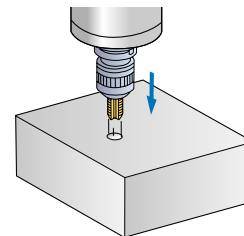

Tool
M30 x P3.5

Spindle speed
212 r/min

Feedrate
742 mm/min (29.2 ipm)

Machining Accuracy

For increased repeatability and reliability

Designed for exceptional high accuracy and minimized thermal displacement and vibration.

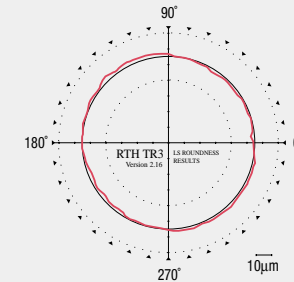

Roundness

5.40 µm

- Model : DNM 500
- Material : A7075F
- Tool : Endmill ø16mm (ø0.6 in.) (4 blades)

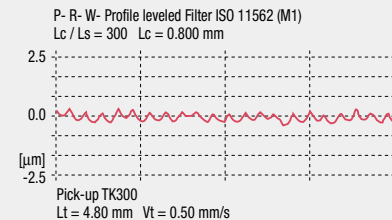

Roughness

Ra 0.12 µm

- Spindle speed : 8000 r/min
- Feedrate : 1000 mm/min (39.4 ipm)

• The results indicated in this catalog may not be obtained due to differences in environmental conditions during measurement and cutting conditions.

Easy Operation Package*

These DOOSAN software packages have been customized to provide user friendly functions.

Tool Table



Work-Piece Set up Table Moving



ATC Recovery Help

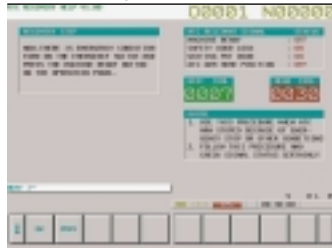

Easy Parameter



G-code Help



M-code Help

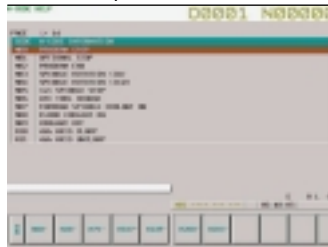

Sensor Status Monitor



Tool Load Monitor opt.



* : Only available in 10.4" Color TFT LCD

Operating Console



1. Swivelling Operating Console

An easy-to-use operation panel which can swivel from 0-90.

2. ATC operating button is arranged to Main Panel



This can give much easier operation and maintenance for ATC.

3. Portable MPG

Portable MPG makes a workpiece setting easier for the operator.



Top cover

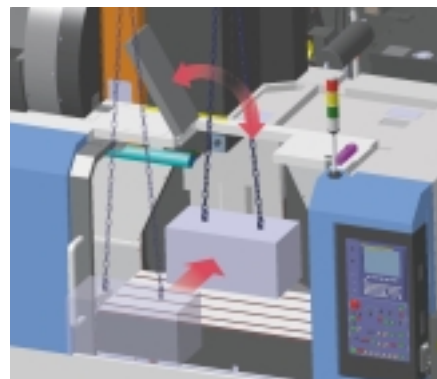

Top cover can be opened to provide easy access for loading heavy workpieces to the center of the table.

Easy setup

Unit : mm (inch)

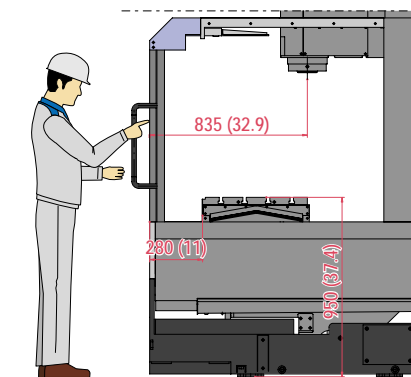

DNM 500

High Rigidity DNM series

Stable bed and column assemblies are designed for high speed and heavy duty machining.



DNM 650 core machine

Compact Structure

Travel axes

Wide machining range select according to workpiece size

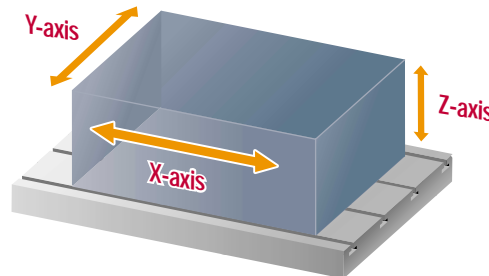

		DNM 400	DNM 500	DNM 650
X-axis	mm (inch)	762 (30.0)	1020 (40.2)	1270 (50.0)
Y-axis	mm (inch)	435 (17.1)	540 (21.3)	670 (26.4)
Z-axis	mm (inch)	510 (20.1)	510 (20.1)	625 (24.6)

The one piece bed is rigid and heavily ribbed Meehanite. These castings remain stable even under the heaviest cutting conditions. Fine grained Meehanite cast iron is used for its excellent vibration absorbing characteristics. The table is fully supported by the saddle in all positions and there is no table overhang. All axes have highly rigid and precise linear motion guideways.

Static rigidity

The high rigidity structure of DNM has raised the static rigidity up by 30% more than previous model with no weak point through FEM analysis.

Dynamic rigidity

Improving the frequency response and the damping ability of vibration makes it possible to increase the high eigenfrequency 35% up on the previous model.

FEM analysis used to design a stable body. (FEM : Finite Element Method)

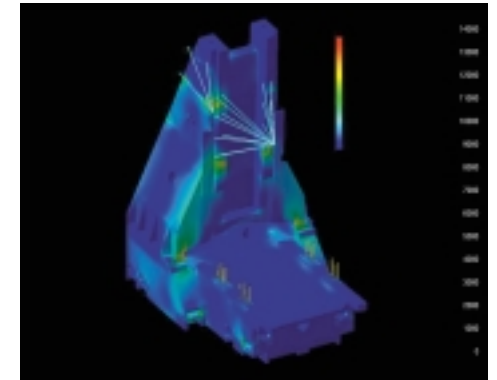



High Speed DNM series

High speed spindle of high quality and rigidity helps increase the efficiency and performance of the machine.

Spindle Head

Max. spindle speed

DNM 400 / 500 / 650	DNM 400HS / 500HS / 650HS
8000 r/min	15000 r/min
12000 r/min <small>opt.</small>	20000 r/min <small>opt.</small>

The spindle of DNM HS series is driven by the powerful built-in motor which has 22 kW power and 167 N·m torque.

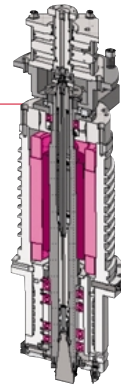

This enables the thermal growth of Y-axis to be reduced by more than 40% of previous model by pulling the air heated by belt out using the FAN with standard function.



Oil cooler

The refrigerated spindle cooling system circulates cooling oil to maintain a constant temperature for high accuracy, regardless of the ambient temperature or cutting conditions.



- DNM HS series std.
- DNM series opt.

Spindle power-torque diagram

DNM 400 / 500
8000 r/min : 11/15 kW (14.8/20.1 Hp)

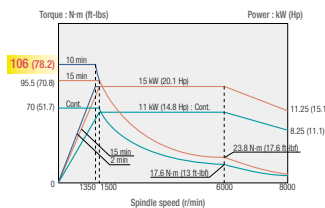

DNM 400 / 500
8000 r/min : 9/11 kW (12.1/14.8 Hp) opt.

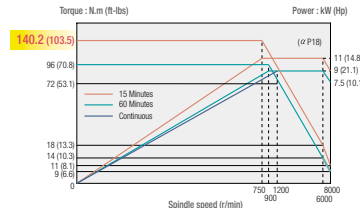

DNM 650
8000 r/min : 15/18.5 kW (20.1/24.8 Hp)

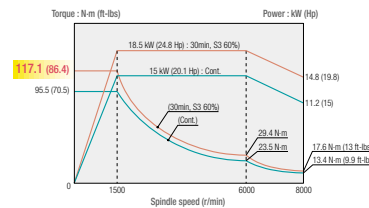

DNM 650
8000 r/min : 9/11 kW (12.1/14.8 Hp) opt.

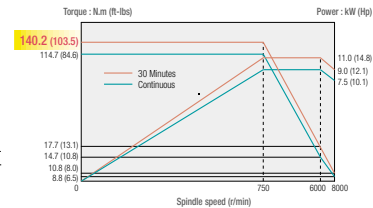

DNM 400 / 500 / 650
12000 r/min : 11/15 kW (14.8/20.1 Hp) opt.

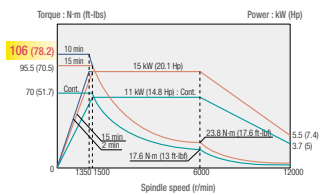

DNM 400HS / 500HS / 650HS
15000 r/min : 18.5/22 kW (24.8/29.5 Hp)

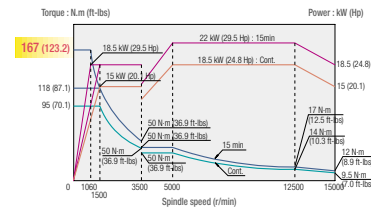

DNM 400HS / 500HS / 650HS
20000 r/min : 11/18.5 kW (14.8/24.8 Hp) opt.

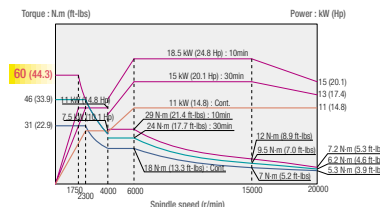

Dual contact (BIG PLUS) std.

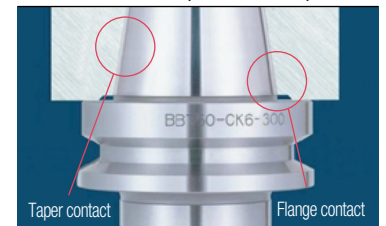

The dual contact system offers simultaneous dual contact between the machine spindle face and tool holder flange face.

Chip Disposal DNM series

Chip treatment from the viewpoint of productivity improvement and environmental countermeasure is important. DNM series offer a variety of chip control equipment to provide enhanced accuracy and better chip removal capabilities.

Easy chip removal structure

The completely enclosed DNM series guarantee the confinement of chips and coolant to the inside of the machining area. Chips fall into the removable forward mounted chip pan for easy disposal.

Through spindle coolant opt.

Middle pressure 1.96 Mpa (284.2 psi)
High pressure 6.86 Mpa (994.7 psi)

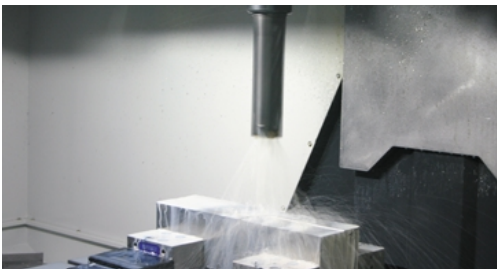

Internal screw conveyor

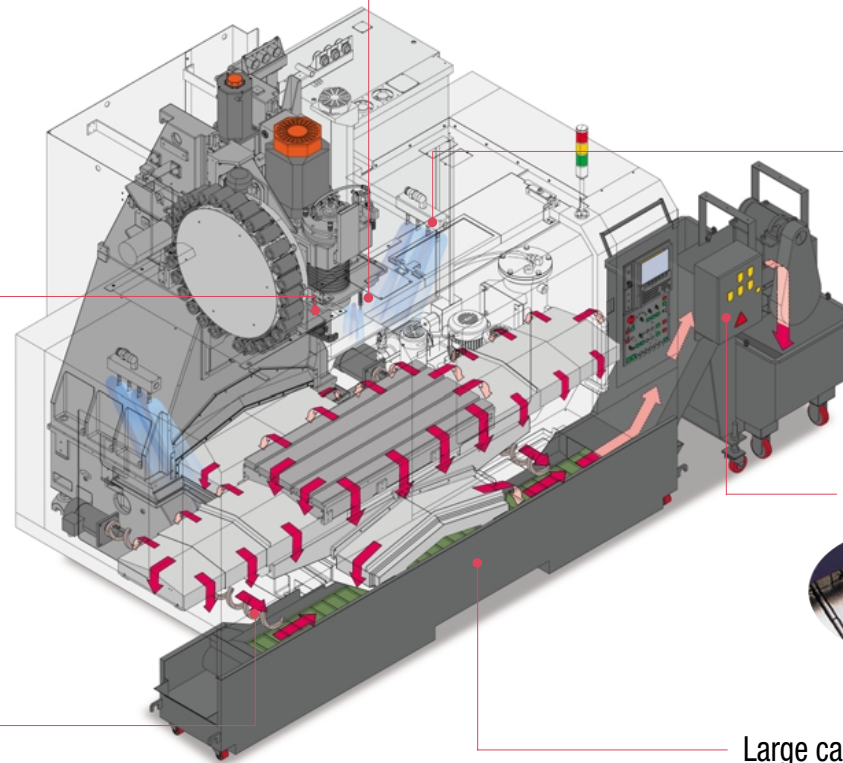
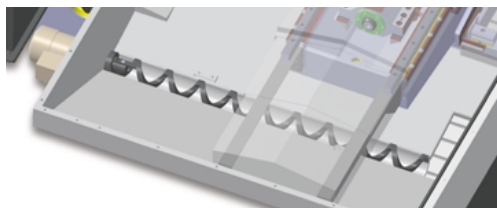

Flood coolant



Shower coolant opt.

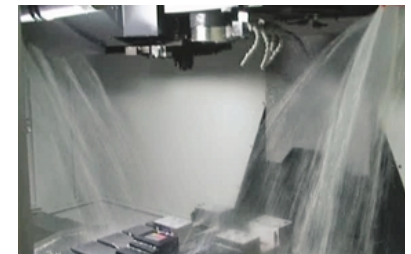

Chip conveyor opt.

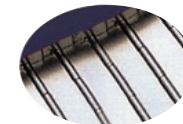

Hinge type



Scraper type



Drum filter type

Large capacity coolant tank with chip pan and box filter

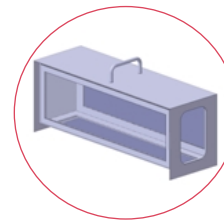

Easy to discard chips piled up

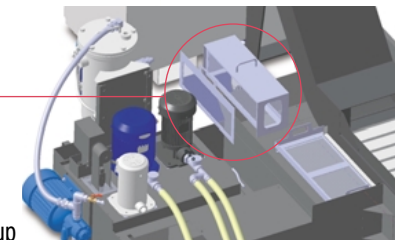

Coolant tank capacity
DNM 400 : 300L (79.3 gal)
DNM 500 : 380L (100.4 gal)
DNM 650 : 380L (100.4 gal)

Optional Equipment DNM series

Operator's convenience and operability

Interface for additional equipment

Connection example of additional 1 axis interface

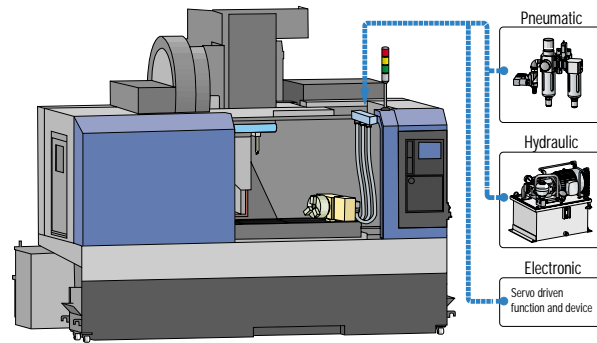

Recommandable rotary table size : DNM 400/500 : $\varnothing 250$ mm (9.84 inch)
 DNM 650 : $\varnothing 320$ mm (12.6 inch)

Hydraulic power unit may be additionally necessary according to rotary table specifications.

Automatic tool length measurement



Automatic workpiece measurement

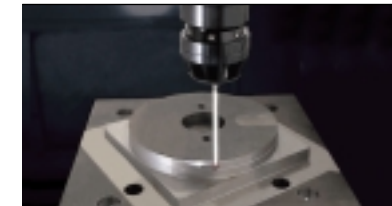

Minimum Quantity Lubrication



Oil skimmer



Connection example of fixture interface

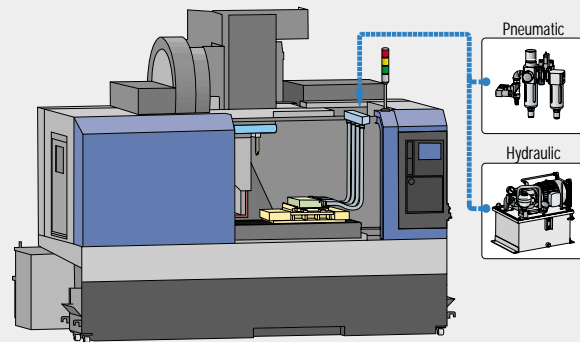

Fixture check list (for hydraulic / pneumatic fixtures)

Pressure source

Hydraulic P/T A/B

Pneumatic P/T A/B

Number of ports

1pair (2-PT 3/8" port)

2pair (4-PT 3/8" port)

3pair (6-PT 3/8" port)

Hydraulic power unit

- Supply scope : User Doosan

(Please check the below detail specification, if you want Doosan to supply.)

Use Doosan standard unit

Special requirement

24 L/min (6.3 gal/min) / 4.9 MPa (711 psi) _____ L/min (gal/min) at _____ MPa (psi)

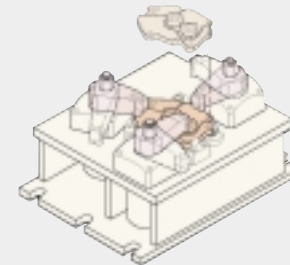

Contact Doosan for more information

External Dimensions

Unit : mm (inch)

DNM 650

Top View

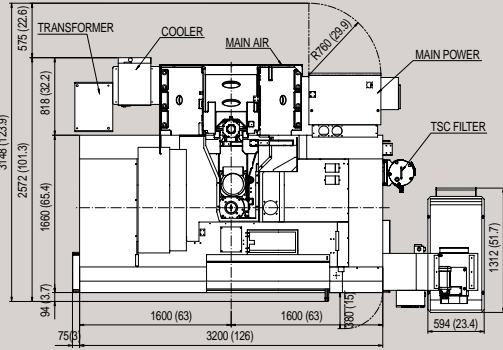

Front View

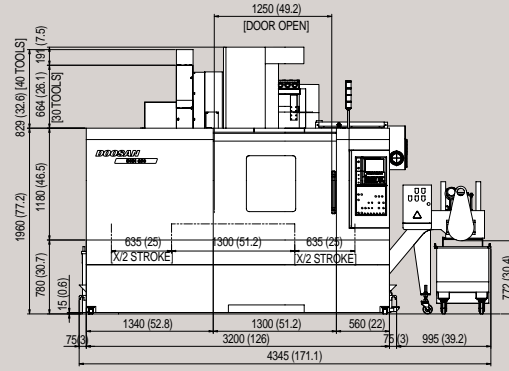

Side View

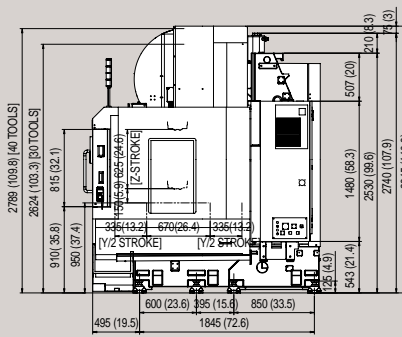

Table

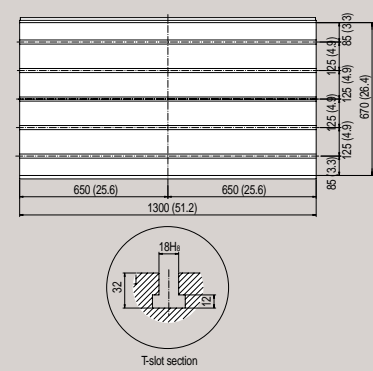

Tool Shank

BT40 Unit : mm

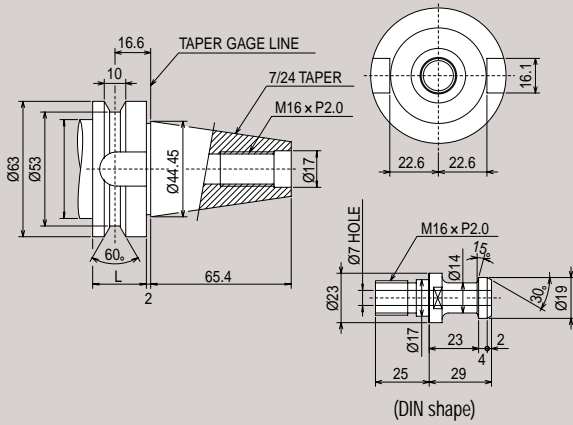

CAT40 Unit : in.

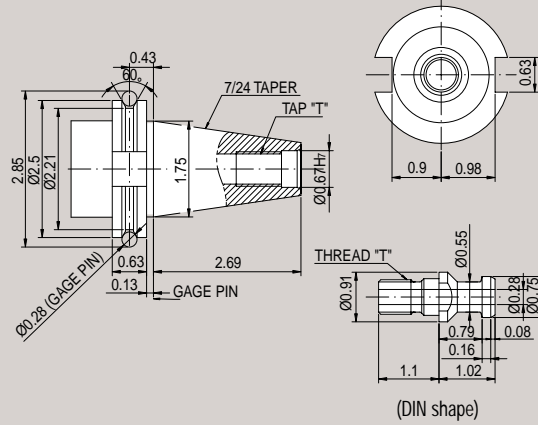

DIN40 Unit : mm

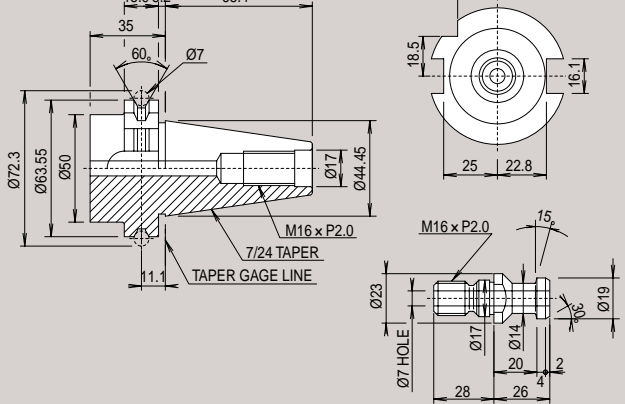

Machine Specifications

Features		DNM 400	DNM 500	DNM 650	DNM 400HS	DNM 500HS	DNM 650HS	
Travel	X-axis	mm (inch)	762 (30.0)	1020 (40.2)	1270 (50.0)	762 (30.0)	1020 (40.2)	1270 (50.0)
	Y-axis	mm (inch)	435 (17.1)	540 (21.3)	670 (26.4)	435 (17.1)	540 (21.3)	670 (26.4)
	Z-axis	mm (inch)	510 (20.1)		625 (24.6)	510 (20.1)		625 (24.6)
	Distance from spindle nose to table top	mm (inch)	150 - 660 (5.9 - 26.0)		150 - 775 (5.9 - 30.5)	150 - 660 (5.9 - 26.0)		150 - 775 (5.9 - 30.5)
	Distance from spindle center to column	mm (inch)	512 (20.2)	587 (23.1)	747 (29.4)	512 (20.2)	587 (23.1)	747 (29.4)
Table	Table size	mm (inch)	920 x 435 (36.2 x 17.1)	1200 x 540 (47.2 x 21.3)	1300 x 670 (51.2 x 26.4)	920 x 435 (36.2 x 17.1)	1200 x 540 (47.2 x 21.3)	1300 x 670 (51.2 x 26.4)
	Table loading capacity	kg (lb)	600 (1322.8)	800 (1763.7)	1000 (2204.6)	600 (1322.8)	800 (1763.7)	1000 (2204.6)
	Table surface		4-125 x 18H ₈		5-125 x 18H ₈	4-125 x 18H ₈		5-125 x 18H ₈
Spindle	Max. spindle speed	r/min	8000 {12000}		15000 {20000}			
	Spindle Taper		ISO #40 7/24 Taper					
	Max. Torque	N·m (ft-lbf)	106 {106} (78.2 {78.2})		117.1 {106} (86.4 {78.2})		167 {60} (123.2 {44.2})	
Feedrate	Rapid traverse rate (X / Y / Z)	m/min (ipm)	36 / 36 / 30 (1417.3 / 1417.3 / 1181.1)			48 / 48 / 48 (1889.8 / 1889.8 / 1889.8)		
	Cutting feedrate	mm/min (ipm)	15000 (590.6)			24000 (944.9)		
Automatic tool changer	Type of tool shank		BT40, CAT40, DIN40					
	Tool storage capacity	ea	cam 30 {cam 40}					
	Max. tool diameter	mm (inch)	Ø80 (3.2) {Ø76 (3.0)}					
	Max. tool diameter without adjacent tools	mm (inch)	Ø125 (4.9)					
	Max. tool length	mm (inch)	300 (11.8)					
	Max. tool weight	kg (lb)	8 (17.6)					
	Method of tool selection		memory random					
	Tool change time (tool-to-tool)	s	1.3					
Motor	Tool change time (chip-to-chip)	s	3.7		3.9		3.7	3.9
	Spindle motor (15 min)	kW (Hp)	15 (20)		18.5 (25)	22 (29.5) {18.5 (25)}		
	Feed motor (X / Y / Z)	kW (Hp)	1.8 / 1.8 / 2.5 (2.4 / 2.4 / 3.4)		4 (5.4)	3.0 / 3.0 / 4.0 (4.0 / 4.0 / 5.4)		4.0 / 4.0 / 7.0 (5.4 / 5.4 / 9.4)
Power source	Electric power supply (Rated capacity)	kVA	30		40	50		
	Compressed air supply	MPa (psi)	0.54 (78.3)					
Tank capacity	Coolant tank capacity	L (gal)	300 (79.3)	380 (100.4)		340 (89.8)	380 (100.4)	
	Lubrication tank capacity	L (gal)	1.4 (0.4)					
Machine size	Machine height	mm (inch)	2703 (106.4)	2703 (106.4)	2815 (110.8)	2703 (106.4)	2703 (106.4)	2815 (110.8)
	Machine dimension (L x W)	mm (inch)	2092 x 2615 (82.4 x 103)	2284 x 3350 (89.9 x 131.9)	2572 x 3350 (101.3 x 131.9)	2092 x 2615 (82.4 x 103)	2284 x 3350 (89.9 x 131.9)	2572 x 3350 (101.3 x 131.9)
	Machine weight	kg (lb)	5500 (12125.2)	6500 (14329.8)	7500 (16534.4)	5000 (11023.0)	6500 (14329.8)	8500 (18739.0)
Controller	NC system	DOOSAN-FANUC i series			FANUC 32i-A			

- Design and specifications are subject to change without notice.
- Doosan is not responsible for difference between the information in the catalogue and the actual machine.

Note : { } are optional.

Standard Feature

- Assembly & operation tools
- Ball screw nut cooling system (HS series)
- Coolant tank & chip pan
- Door interlock for safety
- Flood coolant system
- Installation parts
- Internal screw conveyor
- Operator call lamp (red, yellow, green)
- Portable MPG
- Splash guard
- Work light
- X, Y, Z Absolute pulse coder

Optional Feature

- 10.4" Color TFT LCD**
- 4th axis preparation
- Automatic power off
- Automatic tool length measurement
- Automatic workpiece measurement
- Cam ATC (40 tools)
- Chip conveyor & chip bucket
- EZ Guide i
- Minimum Quantity Lubrication
- Oil cooler & spindle head cooling system*
- Oil skimmer
- Shower coolant
- Test bar
- Through spindle coolant system

* : Standard on 12000 r/min
15000 r/min
20000 r/min
** : Standard on HS series

NC Unit Specifications

DOOSAN-FANUC i series

AXES CONTROL

- Controlled axes	3 (X, Y, Z)
- Simultaneously controllable axes	
- Positioning (G00) / Linear interpolation (G01) : 3 axes	
- Circular interpolation (G02, G03) : 2 axes	
- Backlash compensation	
- Follow up	
- Least command increment	0.001mm (0.0001 inch)
- Least input increment	0.001mm (0.0001 inch)
- Machine lock	all axes / Z axis
- Mirror image	Reverse axis movement (setting screen and M - function)
- Stored pitch error compensation	Pitch error offset compensation for each axis
- Stored stroke check 1	Overtravel controlled by software
- Absolute pulse coder	

INTERPOLATION & FEED FUNCTION

- 2nd reference point return	G30
- Circular interpolation	G02, G03
- Cylindrical interpolation	G07.1
- Dwell	G04
- Exact stop check	G09, G61 (mode)
- Feed per minute	
- Feedrate override (10% increments)	0 - 200 %
- Helical interpolation	
- Jog override (10% increments)	0 - 200 %
- Linear interpolation	G01
- Manual handle	1 units
- Manual handle feedrate	x1, x10, x100 (per pulse)
- Override cancel	M48 / M49
- Positioning	G00
- Rapid traverse override	F0 (fine feed), 25 / 50 / 100 %
- Reference point return	G27, G28, G29
- Skip function	G31

SPINDLE & M-CODE FUNCTION

- M - code function	M 3 digits
- Spindle orientation	
- Spindle serial output	
- Spindle speed command	S5 digits
- Spindle speed override (10% increments)	10 - 150 %

TOOL FUNCTION

- Cutter compensation C	G40, G41, G42
- Number of tool offsets	400 ea
- Tool length compensation	G43, G44, G49
- Tool life management	128 sets
- Tool number command	T2 digits
- Tool offset memory C	Geometry / Wear and Length / Radius offset memory
- Tool position offset	G45 - G48

PROGRAMMING & EDITING FUNCTION

- Absolute / Incremental programming	G90 / G91
- Automatic Coordinate system setting	
- Background editing	
- Canned cycle	G73, G74, G76, G80 - G89, G99
- Circular interpolation by radius programming	
- Custom macro B	
- Decimal point input	
- Extended part program editing	
- I / O interface	RS - 232C
- Inch / metric conversion	G20 / G21
- Label skip	

- Local / Machine coordinate system	G52 / G53
- Maximum commandable value	±99,999,999 mm (±9,999,9999 inch)
- No. of Registered programs	400 ea
- Optional block skip	
- Optional stop	M01
- Part program storage	640m (2,100 ft) [256 KB]
- Program number	04-digits
- Program protect	
- Program stop / end	M00 / M02, M30
- Rigid tapping	G84, G74
- Sub program	Up to 4 nesting
- Tape code	ISO / EIA Automatic discrimination
- Thread cutting	
- Work coordinate system	G54 - G59

OTHERS FUNCTIONS (Operation, setting & Display, etc)

- 3rd / 4th reference return	
- Additional work coordinate system	G54.1 P1 - 48 (48 pairs)
- AI APC/Advanced Preview Control	20 block preview
- Alarm display	
- Alarm history display	
- Automatic corner override	G62
- Clock function	
- Coordinate rotation	G68, G69
- Cycle start / Feed hold	
- Control axis detach	
- Display of PMC alarm message	Message display when PMC alarm occurred
- Dry run	
- Graphic display	Tool path drawing
- Help function	
- High speed skip function	
- Loadmeter display	
- Look ahead control	G08
- MDI / DISPLAY unit	8.4" Color TFT LCD, keyboard for data input (small), soft-keys
- Memory card interface	
- Operation functions	Tape / Memory / MDI / Manual
- Operation history display	
- Optional angle chamfering / corner R	
- Polar coordinate command	G15 / G16
- Program restart	
- Programmable data input	Tool offset and work offset are entered by G10, G11
- Programmable mirror image	G50.1 / G51.1
- Run hour and part number display	
- Scaling	G50, G51
- Search function	Sequence NO. / Program NO.
- Self - diagnostic function	
- Servo setting screen	
- Single block	
- Single direction positioning	G60
- Stored stroke check 2	

OPTIONAL SPECIFICATIONS

- Additional controlled axes	4 axes in total
- AICC (AI Contour Control) with Hardware	40 block preview
- Data server	
- Dynamic graphic display (w/10.4" Color TFT LCD)	Machining profile drawing
- Ethernet function	
- Remote buffer	
- EZ Guide i (Doosan Conversational Programming Solution)	
- with 10.4" Color TFT LCD	
- Tool load monitoring function(doosan)	

FANUC 32i-A

AXES CONTROL

- Controlled axes	3 (X, Y, Z)
- Simultaneously controllable axes	Positioning(G00)/Linear interpolation(G01) : 3 axes Circular interpolation(G02, G03) : 2 axes
- Backlash compensation	
- Emergency stop / overtravel	
- Follow up	
- Least command increment	0.001mm (0.0001 inch)
- Least input increment	0.001mm (0.0001 inch)
- Machine lock	All axes / Z axis
- Mirror image	Reverse axis movement (Setting screen and M - function)
- Stored pitch error compensation	Pitch error offset compensation for each axis
- Stored stroke check 1	Overtravel controlled by software
- Absolute pulse coder	

INTERPOLATION & FEED FUNCTION

- 2nd reference point return	G30
- Circular interpolation	G02, G03
- Dwell	G04
- Exact stop check	G09, G61(mode)
- Feed per minute	
- Feedrate override (10% increments)	0 - 200 %
- Jog override (10% increments)	0 - 200 %
- Linear interpolation	G01
- Manual handle feed 1 unit	
- Manual handle feedrate	x1, x10, x100(per pulse)
- Override cancel	M48 / M49
- Positioning	G00
- Rapid traverse override	F0 (time feed), 25 / 50 / 100 %
- Reference point return	G27, G28, G29
- Skip function	G31
- Helical interpolation	
- DSQ1(AICC II + Machine condition selection function)	80 block preview
- Thread cutting, synchronous cutting	
- Program restart	
- Automatic corner deceleration (Specify AI Contour control II)	
- Feedrate clamp by circular acceleration (Specify AI Contour control II)	
- Linear ACC/DEC before interpolation (Specify AI Contour control II)	
- Linear ACC/DEC after interpolation	
- Rapid traverse bell-shaped acceleration/deceleration	
- Smooth backlash compensation	

SPINDLE & M-CODE FUNCTION

- M - code function	M3 digits
- Spindle orientation	
- Spindle serial output	
- Spindle speed command	S5 digits
- Spindle speed override (10% increments)	10 - 150 %
- Spindle output switching	
- Retraction for rigid tapping	
- Rigid tapping	G84, G74

TOOL FUNCTION

- Tool nose radius compensation	G40, G41, G42
- Number of tool offsets	64 ea
- Tool length compensation	G43, G44, G49
- Tool number command	T2 digits
- Tool life management	Geometry / Wear and Length / Radius offset memory
- Tool offset memory C	
- Tool length measurement	

PROGRAMMING & EDITING FUNCTION

- Absolute / Incremental programming	G90 / G91
- Auto. Coordinate system setting	
- Background editing	
- Canned cycle	G73, G74, G76, G80 - G89, G99
- Circular interpolation by radius programming	
- Custom macro B	
- Custom size 512KB	
- Decimal point input	
- I / O interface	RS - 232C
- Inch / metric conversion	G20 / G21
- Label skip	
- Local / Machine coordinate system	
- Maximum commandable value	±99999,999 mm (±9999,9999 inch)
- No. of Registered programs	500 ea
- Optional stop	M01

- Part program storage	640m (2,100ft) [256KB]
- Program number	04-digits
- Program protect	
- Program stop / end	M00 / M02, M30
- Programmable data input	Tool offset and work offset are entered by G10, G11
- Sub program	Up to 4 nesting
- Tape code	ISO / EIA Automatic discrimination
- Work coordinate system	G54 - G59
- Additional work coordinate system (48 Pair)	G54.1 P1 - 48 pairs
- Coordinate system rotation	G68, G69
- Extended part program editing	
- Optional angle chamfering / corner R	
- Macro executor	

OTHERS FUNCTIONS (Operation, Setting & Display, etc)

- Alarm display	
- Alarm history display	
- Clock function	
- Cycle start / Feed hold	
- Control axis detach	
- Display of PMC alarm message	Message display when PMC alarm occurred
- Dry run	
- Ethernet function(Embedded)	
- Graphic display	Tool path drawing
- Help function	
- Loadmeter display	
- MDI / DISPLAY unit	10.4" Color TFT LCD, Keyboard for data input, soft-keys
- Memory card interface	
- Operation functions	Tape / Memory / MDI / Manual
- Operation history display	
- Program restart	
- Run hour and part number display	
- Search function	Sequence NO. / Program NO.
- Self - diagnostic function	
- Servo setting screen	
- Single block	
- External data input	
- Multi language display	
- Stored stroke check 2	

OPTIONAL SPECIFICATIONS

- 3-dimensional coordinate conversion	
- 3-dimensional tool compensation	
- 3rd / 4th reference return	
- Addition of tool pairs for tool life management	1024 pairs
- Additional controlled axes	Max. 5 axes in total
- Additional work coordinate system	G54.1 P1 - 300 (300 pairs)
- DSQ 2	80 block preview
- (AICC II + Machine condition selection function + Data server + 1GB)	
- Automatic corner override	G62
- Chopping function	G81.1
- Cylindrical interpolation	G07.1
- Dynamic graphic display	Machining profile drawing
- Exponential interpolation	
- Interpolation type pitch error compensation	
- EZ Guide i (Doosan Infracore Conversational Programming Solution) with 10.4" Color TFT	
- => When the EZ Guide i is used, the Dynamic graphic display cannot application	
- Tape format for RS15	
- Increment system 1/10	
- Figure copying	G72.1, G72.2
- Handle interruption	
- High speed skip function	
- Involute interpolation	G02.2, G03.2
- Machining time stamp function	
- No. of Registered programs	1000 ea
- Number of tool offsets	99 / 200 / 400 pairs
- Optional block skip addition	9 blocks
- Part program storage	512K / 1M / 2M byte
- Playback function	
- Polar coordinate command	G15 / G16
- Polar coordinate interpolation	G12.1 / G13.1
- Programmable mirror image	G50.1 / G51.1
- Single direction positioning	G60
- Tool load monitoring function(Doosan)	
- Tool position offset	G45 - G48
- Position switch	

*) Pre discussion required

DNM Series

High Productivity Vertical Machining Center



Doosan Infracore
Machine Tools

<http://domss.doosaninfracore.com>

Head Office :

Doosan Tower 22nd FL., 18-12, Euljiro-6Ga, Jung-Gu, Seoul, Korea 100-730

Tel : ++82-2-3398-8651 Fax : ++82-2-3398-8699 E-mail : master@domss.com

Doosan Infracore America Corp.:

8 York Avenue, West Caldwell, NJ 07006, U.S.A. Tel : ++1-973-618-2500 Fax : ++1-973-618-2501

Doosan Infracore Germany GmbH :

Hans-Böckler-Strasse 29, D-40764 Langenfeld-Fuhrkamp, Germany. Tel : ++49-2173-8509-10 Fax : ++49-2173-8509-60

China Representative Office :

Building 13, Room. 140 Tianlin Road, Shanghai City (200233) Tel : ++86-21-6440-3384(808, 805) Fax : ++86-21-6440-3389